



## DOT - ANTIPODE



<b>type</b>	suspension				
<b>materials</b>	body :	brass			
	spheres :	milk glass (G50 + G100)			
	hardware :	brass			
<b>height</b>	8 ½"	14 ½"	20 ½"	26 ½"	38 ½"
	216 mm	368 mm	521 mm	673 mm	978 mm
<b>weight</b>	min. 2 lb / 0.9 kg - max. 2.5 lb / 1.1 kg				
<b>light bulb</b>	LED (included), 1x 4.5W + 1x 3.5W				
<b>sockets</b>	G9				
<b>voltage</b>	120V / 240V				
<b>dimmer</b>	refer to our recommended list of dimmer models				
<b>certifications</b>	 				
<b>notes</b>	<ul style="list-style-type: none"> <li>- must be installed by an electrician;</li> <li>- additional charges for modifications or for special orders;</li> <li>- lead time between 7-9 weeks;</li> <li>- dimensions are approximate and may vary slightly.</li> </ul>				

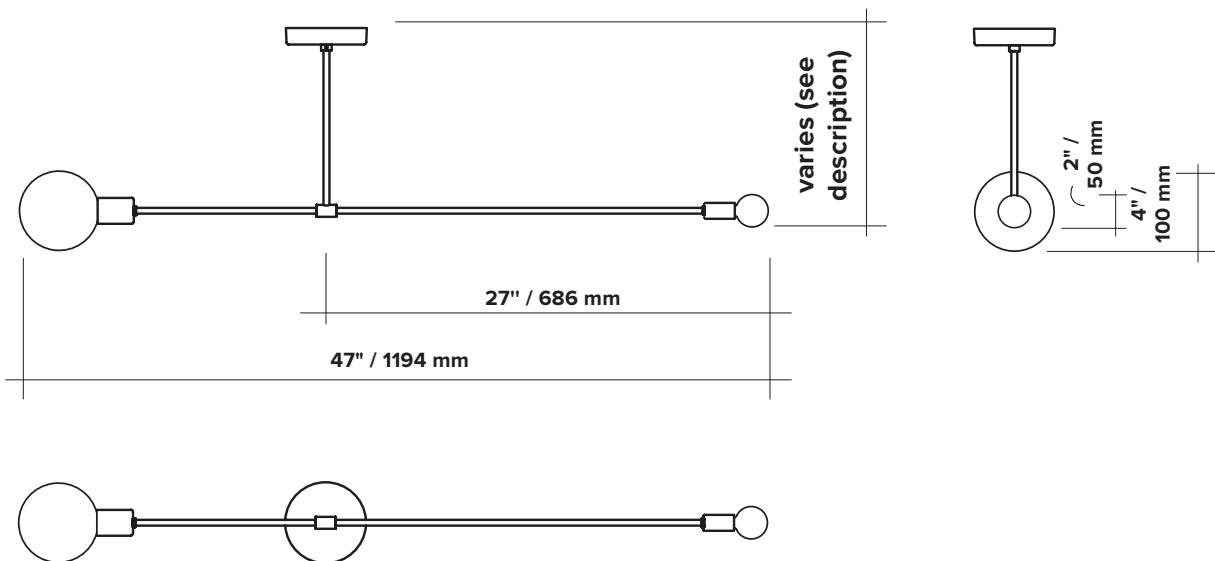

## ORDER GUIDE: SKU

COLLECTION		MODEL	FINISH		HEIGHT	
DOT	dot	07	BR	brass	A	8 ½" / 216 mm
			GR	graphite	B	14 ½" / 368 mm
					C	20 ½" / 521 mm
					D	26 ½" / 673 mm
					E	38 ½" / 978 mm
					V	custom
<b>DOT</b>		<b>07</b>	<b>BR</b>		<b>A</b>	<b>= DOT07BRA</b>
						<b>example</b>

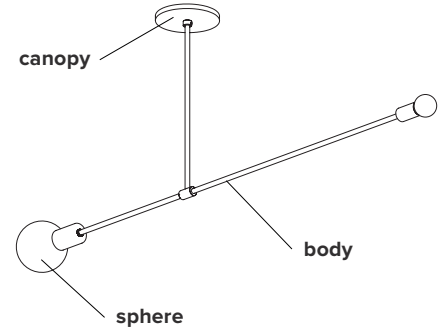

### FINISH



brass



graphite

### CANOPY swivel option for slanted ceiling

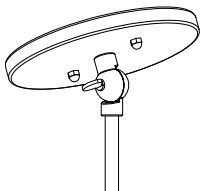

## LIGHT BULB & DIMMER SPECIFICATIONS

### G9 SOCKETS

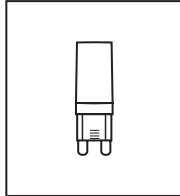

Frosted  
4.5W  
100V-120V / 240V  
450 Lumens  
2700 K  
25 000 H  
CRI ≥80  
2 years warranty

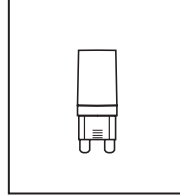

Frosted  
3.5W  
100V-120V / 240V  
350 Lumens  
2700 K  
25 000 H  
CRI ≥80  
2 years warranty

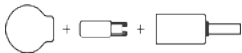

### SPHERES



G100 Ø ±4" / 100 mm



G50 Ø ±2" / 50 mm

### DIMMER LIST COMPATIBILITY FOR G9 LED BULBS – 120V

The dimming technology offering the best results is ELV (electronic low voltage) dimmers with reverse phase or trailing edge control.

<u>DIMMER BRAND</u>	<u>MODEL NUMBER</u>	<u>MAX LEVEL</u>	<u>MIN LEVEL</u>	<u>FLICKERING</u>	<u>OVERALL QUOTE</u>
LUTRON - MAESTRO	MAELV-600	100%	0%	0%-10%	good
LUTRON - SKYLARK	SELV-300P	100%	0%	no	very good
LUTRON - SKYLARK	SELV-303P	100%	0%	no	very good
LUTRON - SKYLARK	CTELV-303P	100%	0%	no	very good
LUTRON - DIVA	DVELV-300P	100%	0%	no	very good
LEGRAND - ADORNE	TRUE UNIVERSAL	100%	30%	no	good

### DIMMER LIST COMPATIBILITY FOR G9 LED BULBS – 230V

<u>DIMMER BRAND</u>	<u>MODEL NUMBER</u>	<u>MAX LEVEL</u>	<u>MIN LEVEL</u>	<u>FLICKERING</u>	<u>OVERALL QUOTE</u>
VARILIGHT	V-PRO	100%	2%	no	very good
LEGRAND - NILOÉ	3 996 35	87%	15%	no	good
NIKO	310-0280X	94%	5%	no	very good
NIKO	310-0190X	100%	1%	no	very good

\*Other dimmers can yield good results and we recommend conducting your own test before final installation.